

Article number: 203160M16100B1U

Description: E+G levelling foot
GN 31-60-M16-100-B1-U

Note: U Without nut, Hexagon socket at the top, Wrench flat at the bottom

Measures

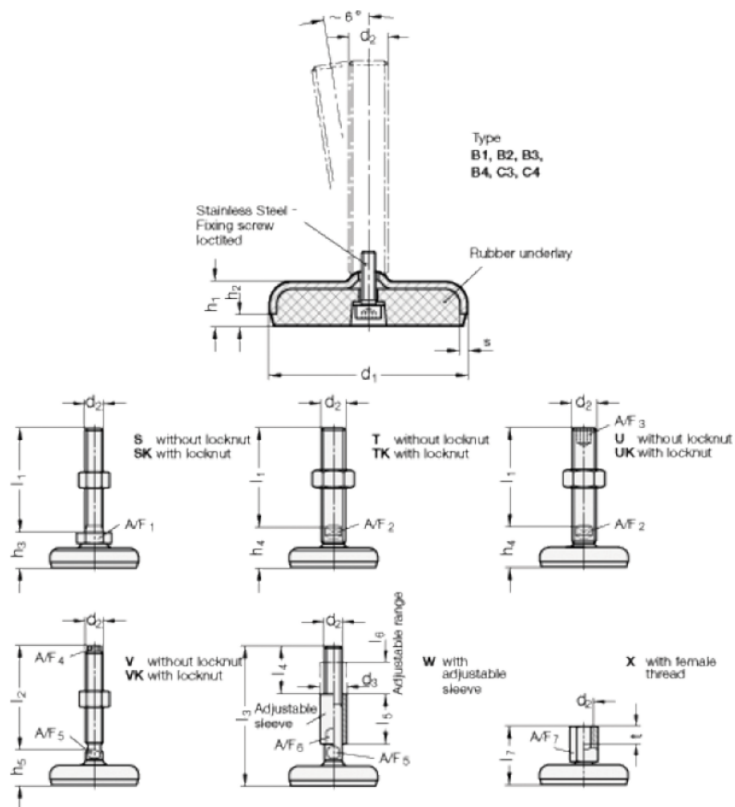

A/F2	= 12	s = 3
A/F3	= 8	
d1	= 60	
d2	= 16	
h1	= 16	
h4 +4.0/0	= 30	
l1	= 100	